

PLAN

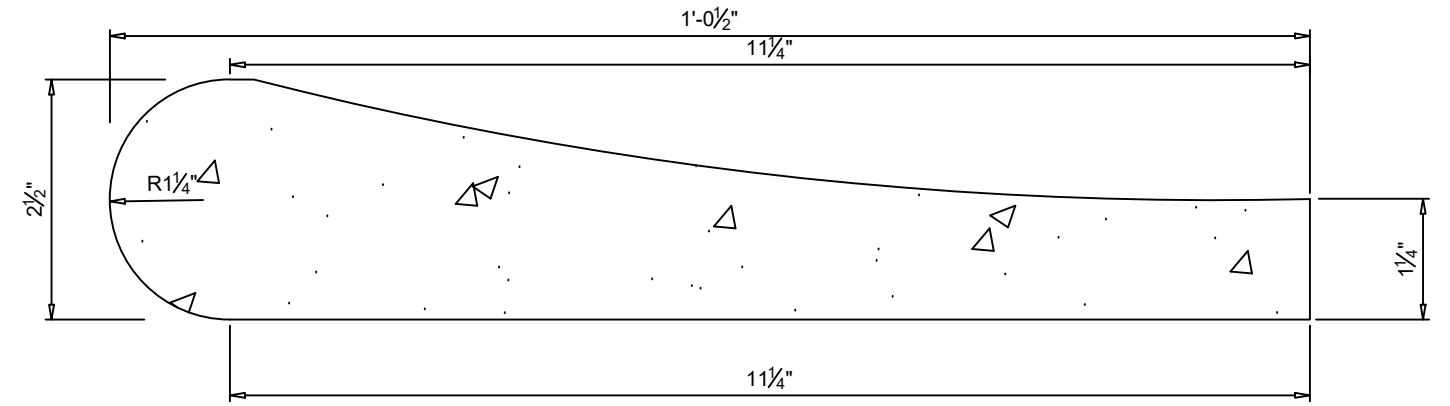

SECTION

SCALE: HALF

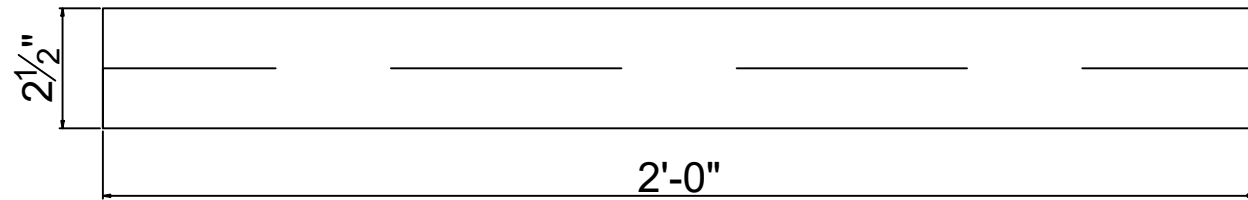

ELEVATION

SCALE: 3"=1'-0"



TRRIMSTONE PRODUCTS, LLC
 WWW.TRRIMSTONE.COM
 661.947.1001

Description: Precast Concrete Pool Coping			
ITEM: AS12	REQD QTY:	Date: 3/26/24	Sheet No 1
Project:		Drawn:	
		Chk'd:	
		Job No:	

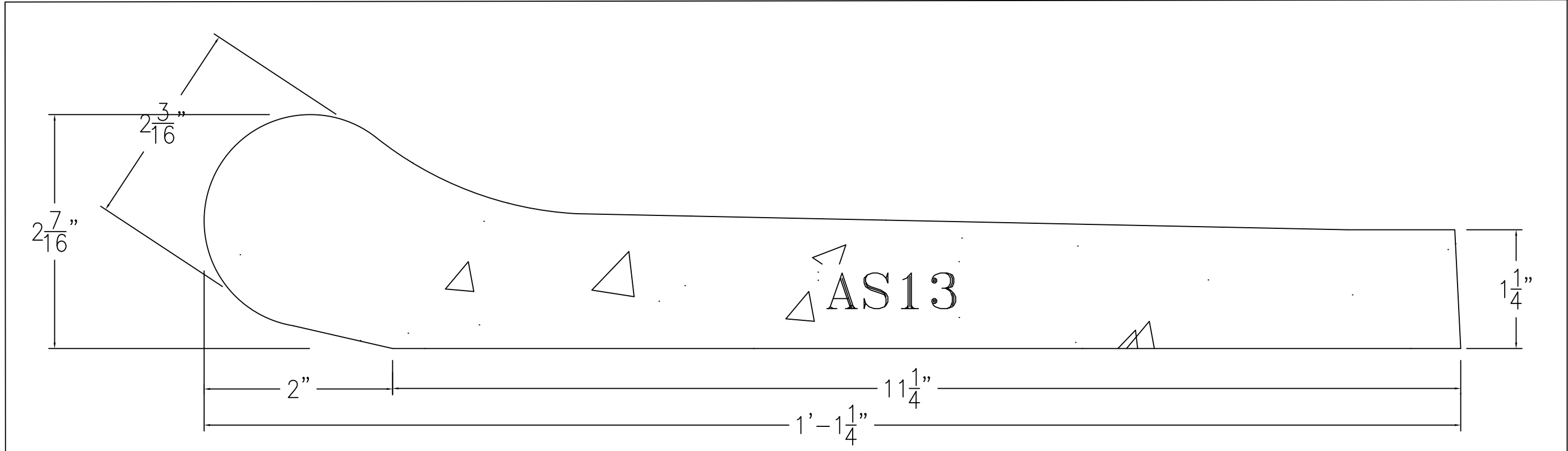

Available in
 -Straights 24" Long
 -Corners & Various Radii

Description:			
Precast Concrete SAFETY GRIP Pool Coping			
ITEM:	REQD QTY:	Date: July 2019	Sheet No
		Drawn:	AS13
Project:		Chk'd:	
Andora Series		Job No:	

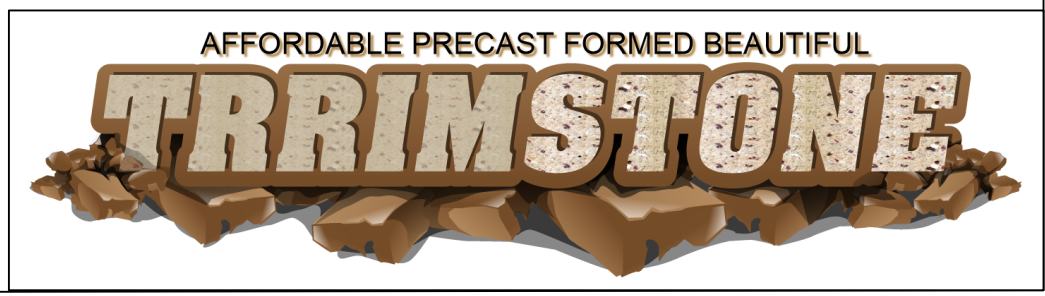

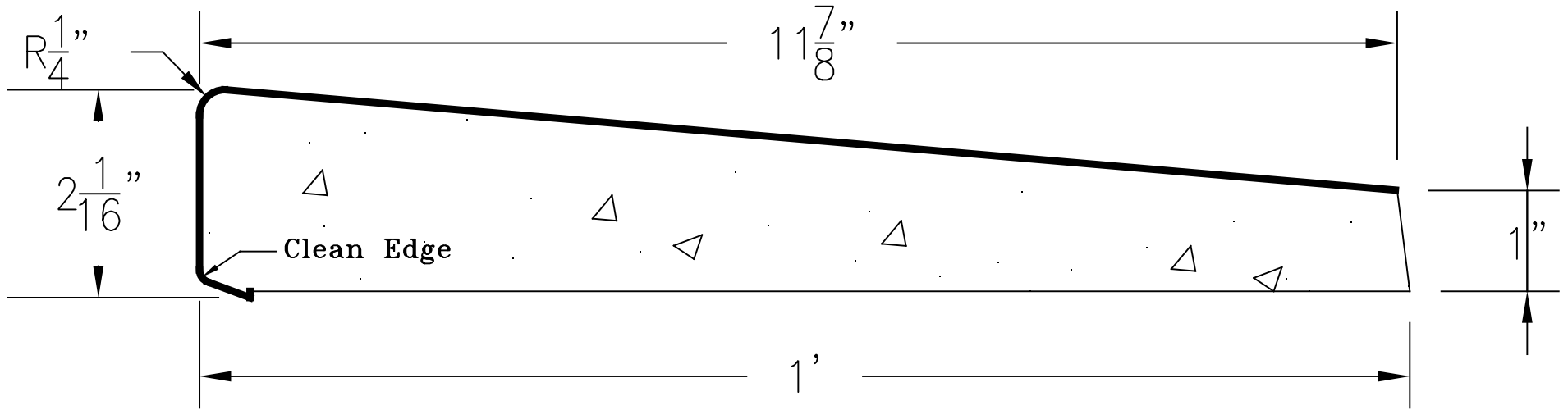

Description:

Precast Concrete/Cast Stone Pool Coping

ITEM:	REQD QTY:	Date:	Sheet No
CS12		Drawn:	CS12
Project:		Chk'd:	
CANTILEVERED SERIES		Job No:	



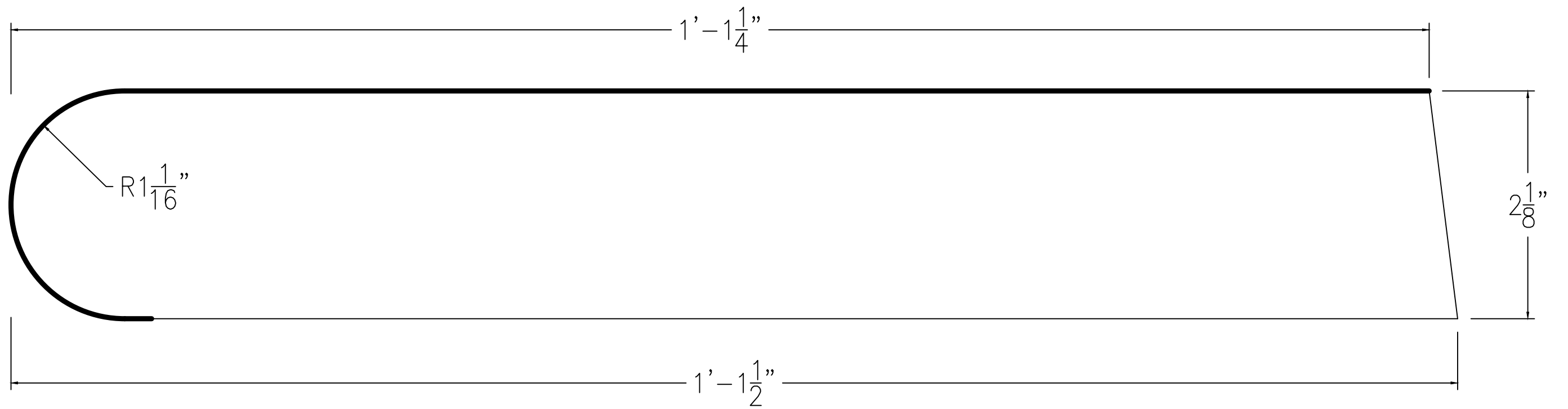

Description: Precast Concrete Pool Coping			
ITEM:	REQD QTY:	Date:	Sheet No
GS13		Drawn:	GS13
Project:		Chk'd:	
GENOA SERIES		Job No:	



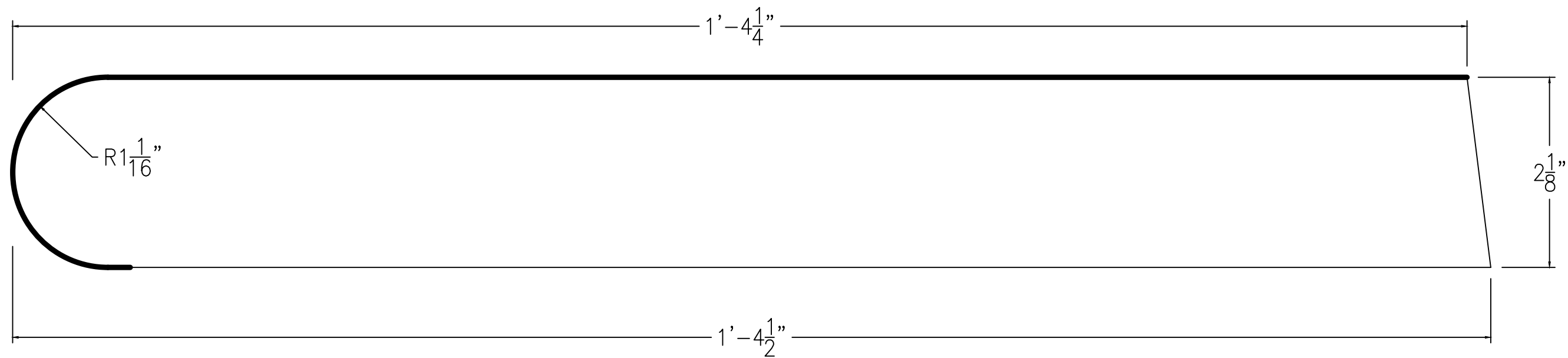

Description:			
Precast Concrete Pool Coping			
ITEM:	REQD QTY:	Date:	Sheet No
GS16		Drawn:	
Project:		Chk'd:	GS16
GENOA SERIES		Job No:	



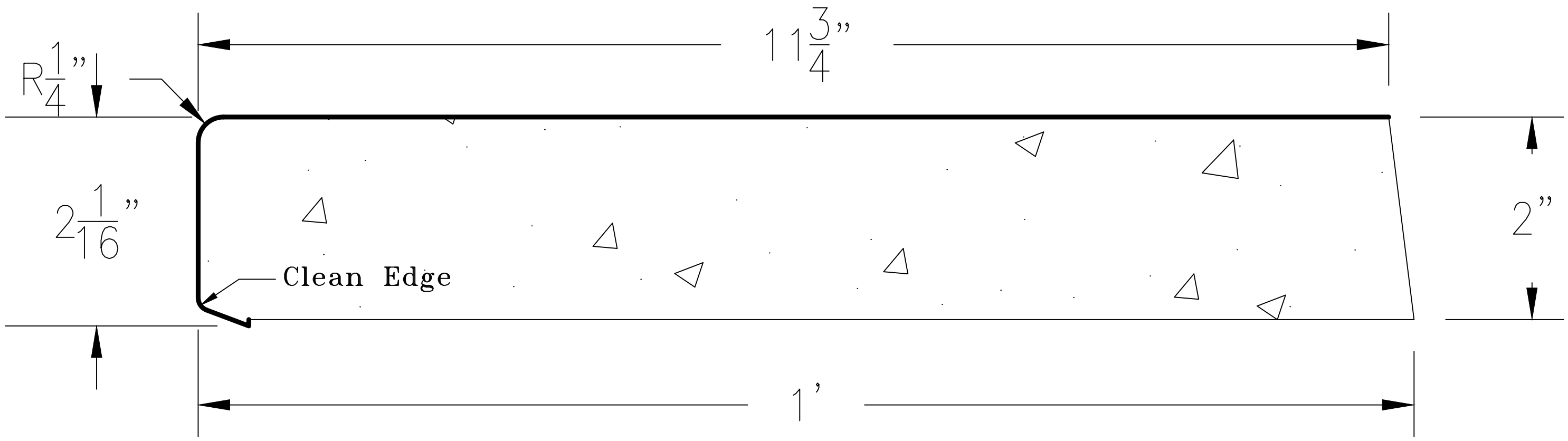

Description:			
Precast Concrete Pool Coping			
ITEM:	REQD QTY:	Date:	Sheet No
LV12		Drawn:	LV12
Project:		Chk'd:	
LA VELLA SERIES		Job No:	



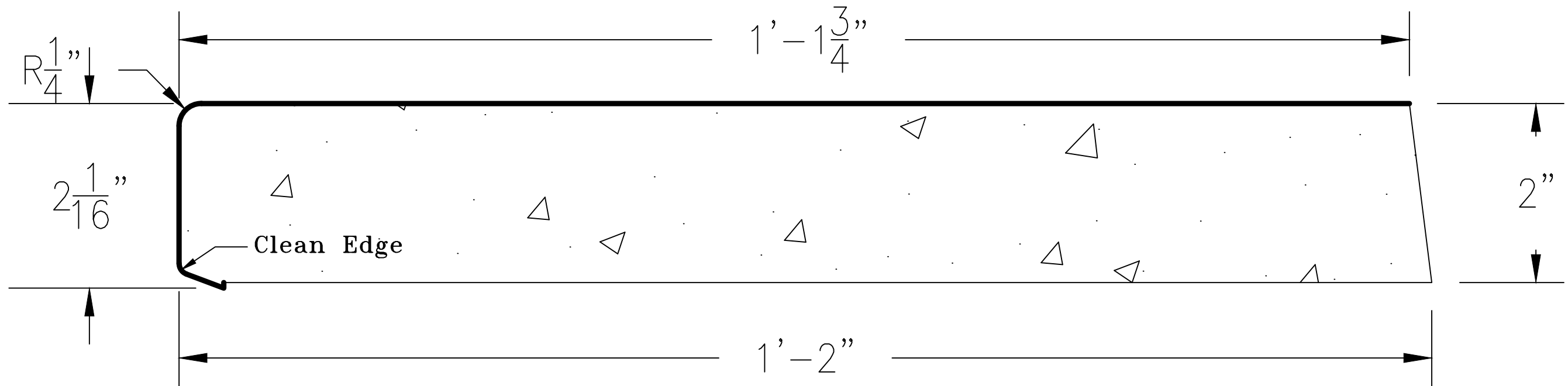

Description:			
Precast Concrete Pool Coping			
ITEM:	REQD QTY:	Date:	Sheet No
LV14		Drawn:	LV14
Project:		Chk'd:	
LA VELLA SERIES		Job No:	



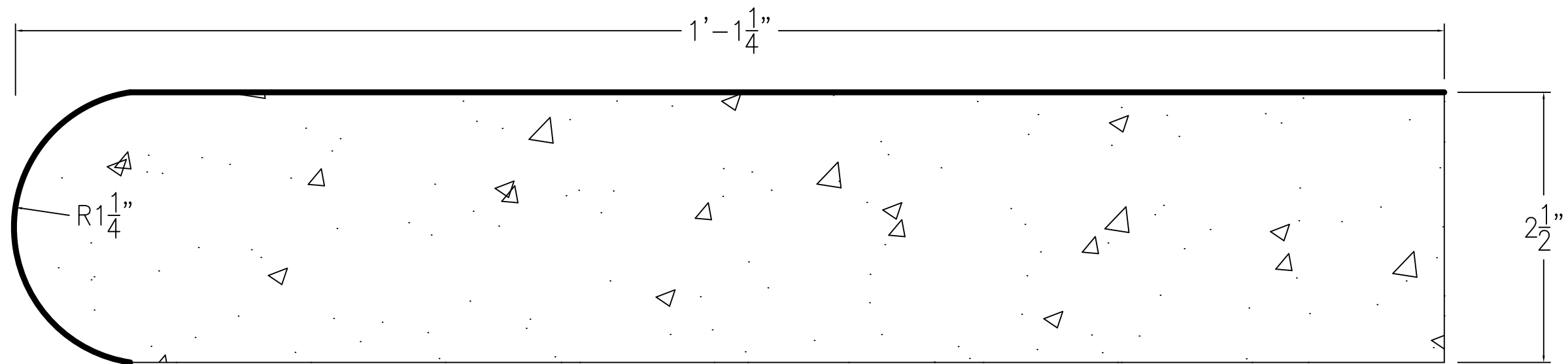

Size: 13-1/4" x 24" x 2.5"
 Min. 4000 PSI
 Set on min. 1/2 Setting Bed
 Color: To be Determined

Description:			
Precast Concrete Pool Coping			
ITEM:	REQD QTY:	Date:	Sheet No
GS13.25		Drawn:	
Project:		Chk'd:	
King Open, Cambridge, MA		Job No:	



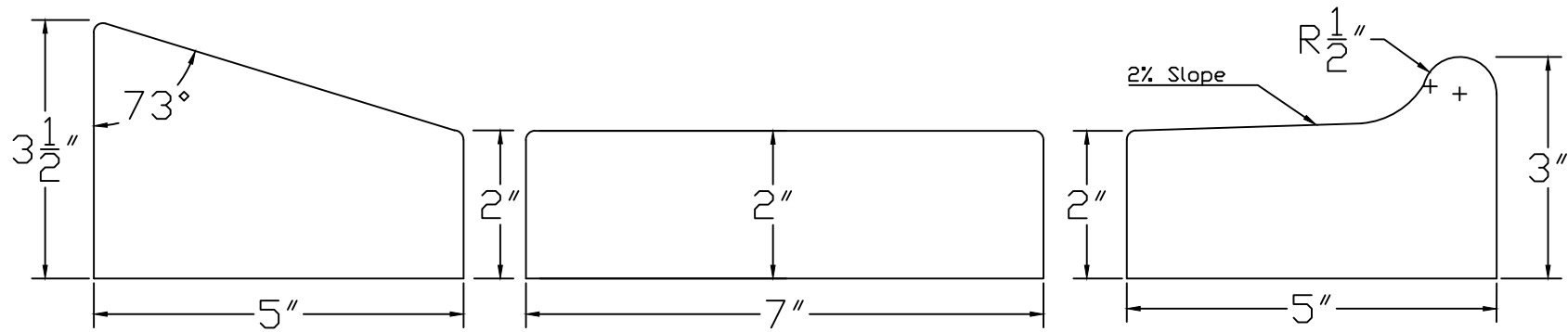

Three Piece Pool Coping

11 / 9 / 2021



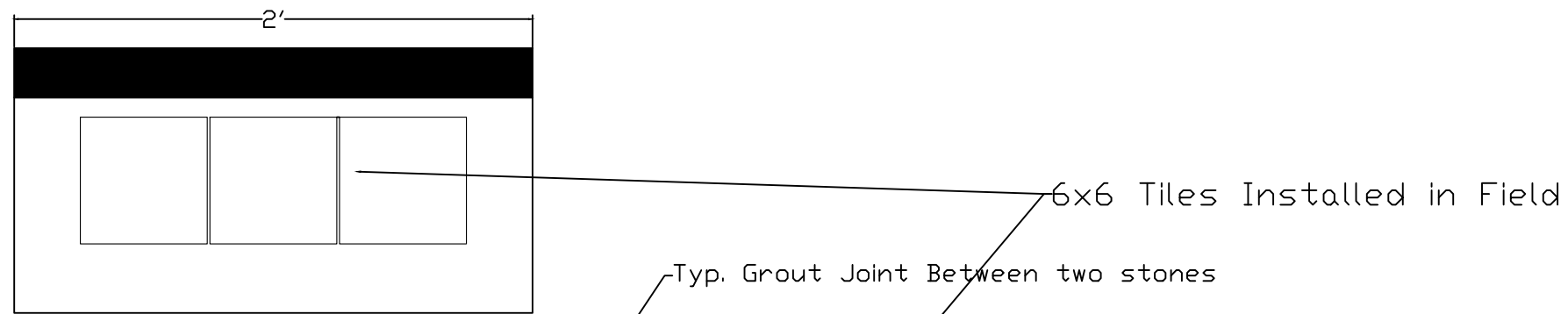

3 Tiles on 1 -- 2ft piece

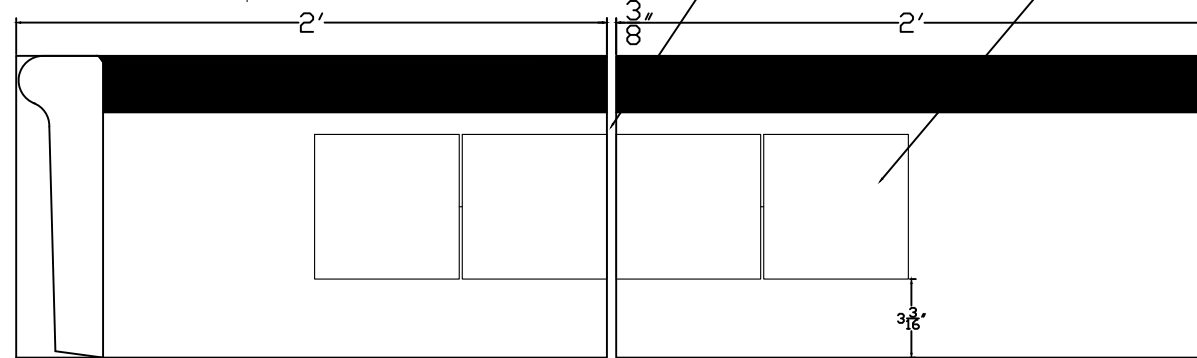

4 Tiles on 2 -- 2ft pieces

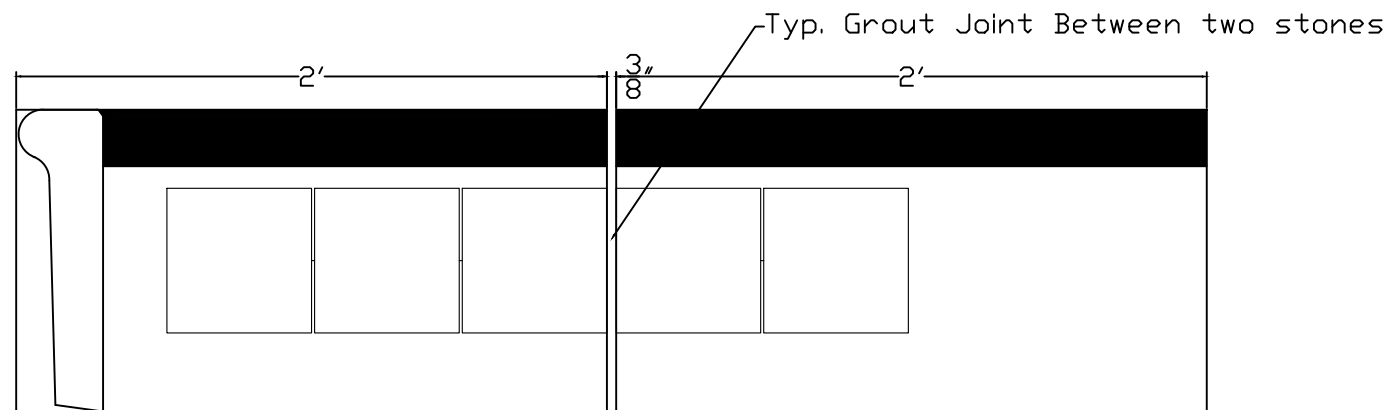

5 Tiles on 2 -- 2ft pieces

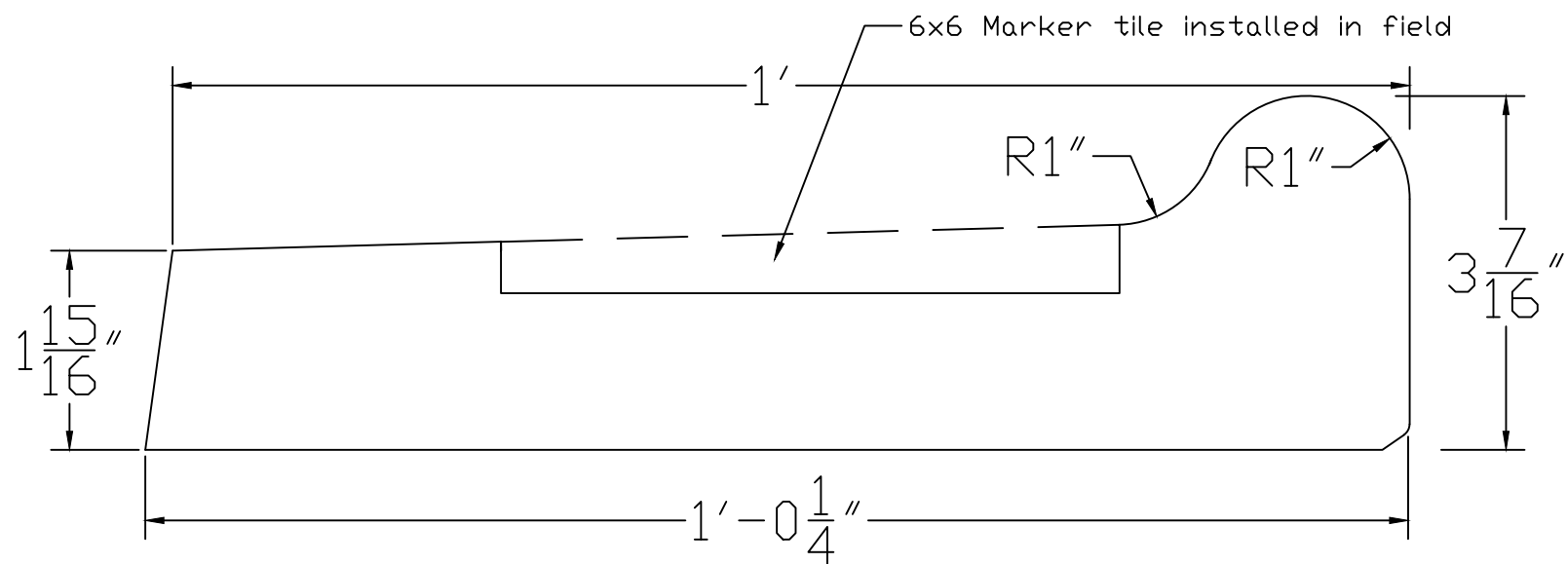

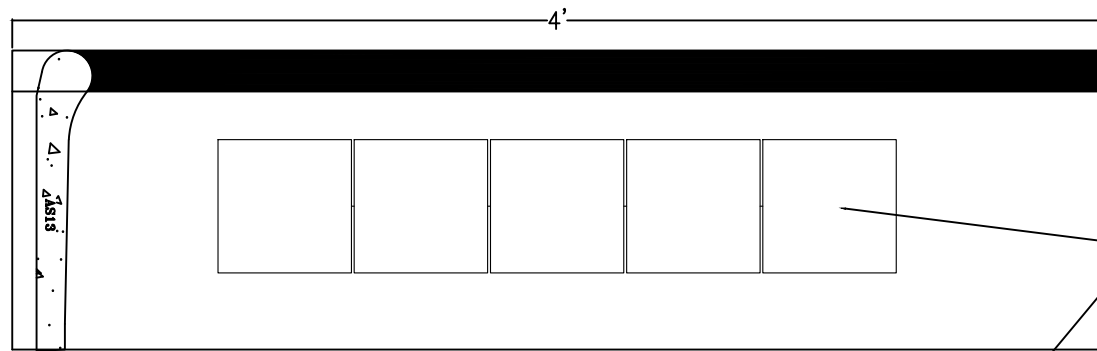

5 Tile Marker on 4ft Piece

6x6 Tiles

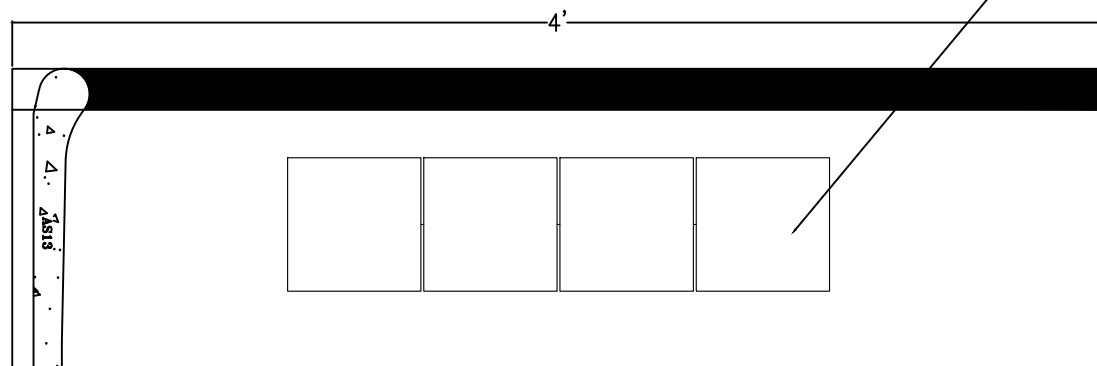

4 Tile Marker on 4ft Piece

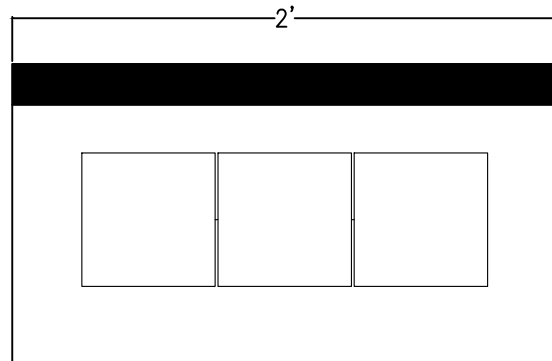

3 Tile Marker on 2ft Piece

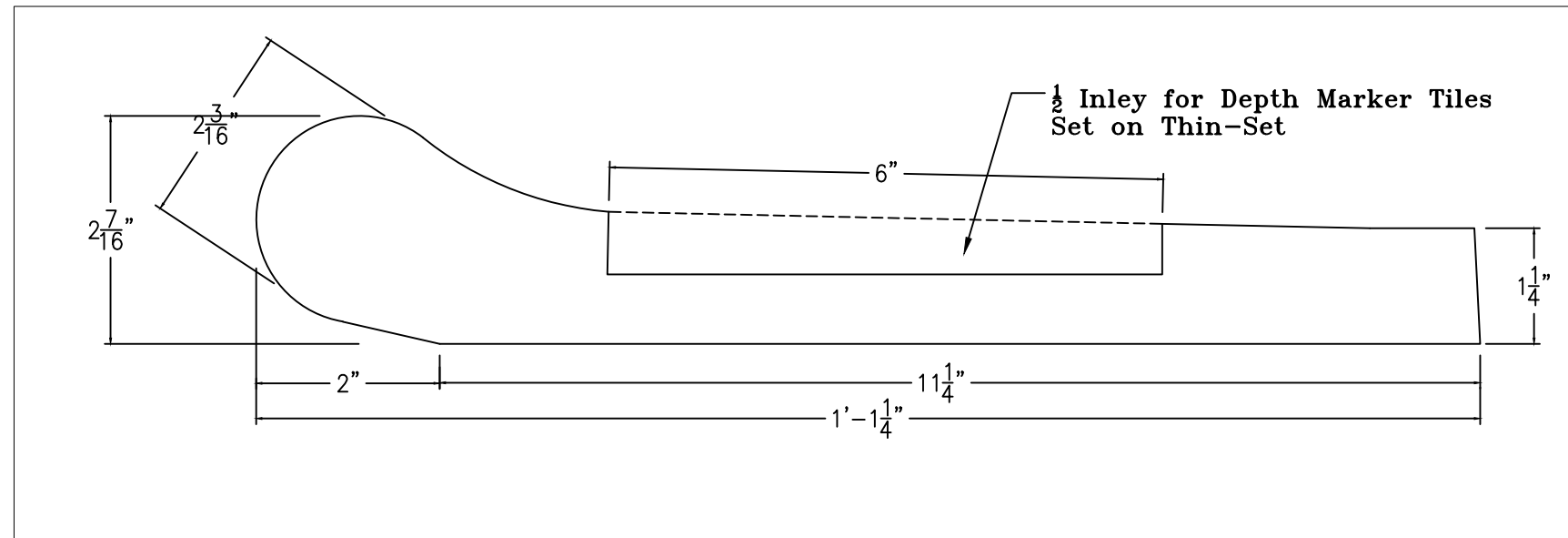

Description:			
Precast Concrete SAFETY GRIP Pool Coping			
ITEM:	REQD QTY:	Date:	Sheet No
		Drawn:	AS13
Project:		Chk'd:	
Andora Series		Job No:	

