

TRIMSTONE®.com

**Architectural Cast-Stone/ Precast Mouldings, Sills & Keystones
For Door, Window and Garage Surrounds**

TUSCANY COLLECTION

**A superior
alternative to EPS
Styrofoam.**



**Trimstone product line.
Truly an Architectural
Elegance of Decorative Stone.
*Trimstone®***

Durability, beauty, elegance and price makes this the “Product Of Choice” for window and door surrounds

- Stock Item (No More Job Delays)
- Affordable For Every Home
- As Low as Finished Styrofoam
- 50% Less Than Market Price
- Market Price ~~\$10 L.F.~~, Our Price \$4.75 L.F.
- High Quality
- Maintenance Free
- Radius Available
- Easy Installation
- Lowest Price Guaranteed





More photos are available on our website: www.trimstone.com

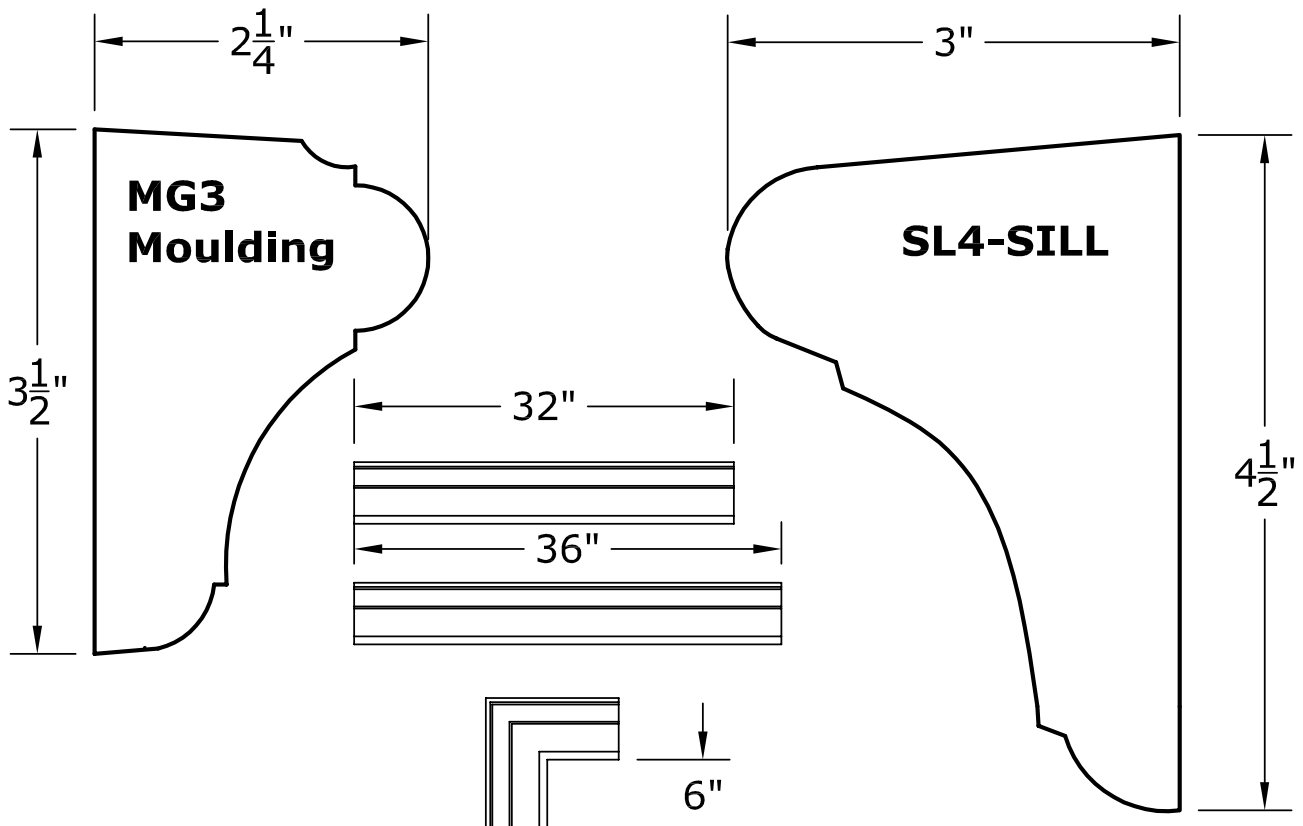
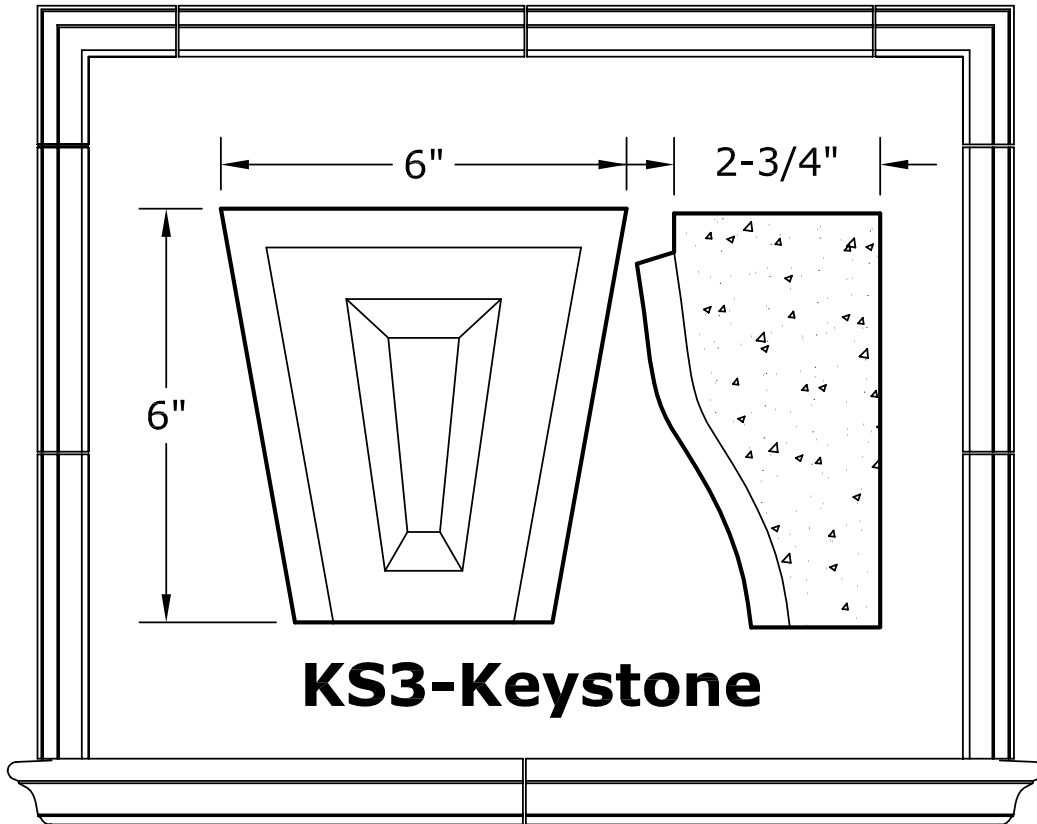

Available in 32 inch & 36 inch lengths
Corner Piece is 12" X 12"
(Outer Edge)

Available in 24 inch & 32 inch lengths
Left & Right Ends available

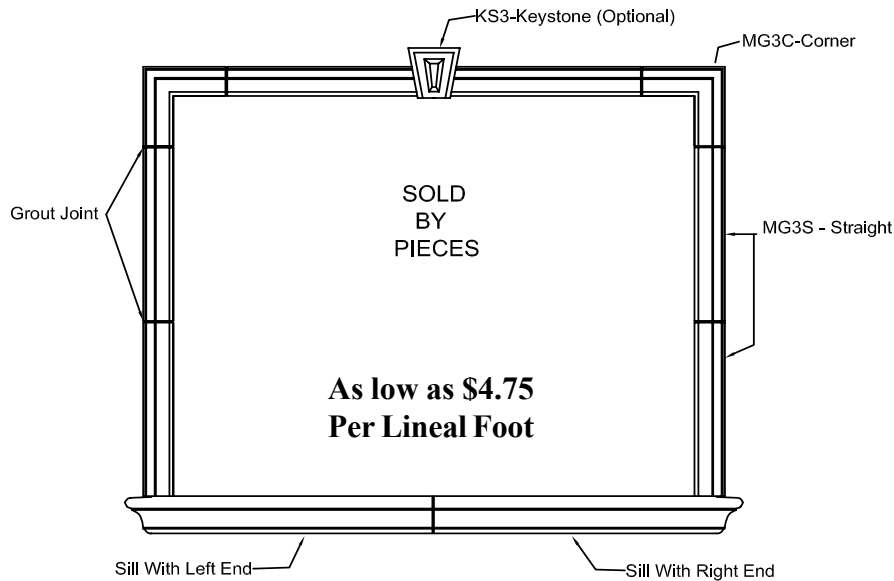

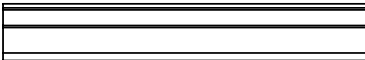
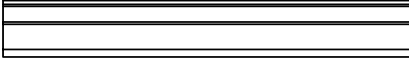
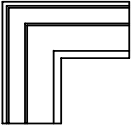
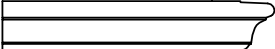
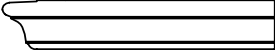
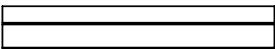
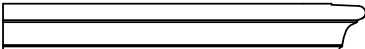
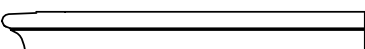
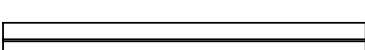
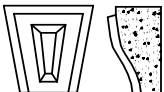
Mouldings	Item	Description	Weight LBS	MSRP/ Price Per Piece
	MG3S	3-1/2" Moulding, 32" Long	12	\$10.75
	MG3L	3-1/2" Moulding, 36" Long	11	\$12.75
	MG3C	Corner (6" X 6" inside)	5.5	\$ 7.25
Sills (Short)				
	SL4S-RE	4-1/2" Sill, With Right End, 24" Long	15	\$11.75
	SL4S-LE	4-1/2" Sill, With Left End, 24" Long	15	\$11.75
	SL4S-NE	4-1/2" Sill, With No Ends, 24" Long	15	\$11.75
Sills (Long)				
	SL4L-RE	4-1/2" Sill, With Right End, 32" Long	17	\$14.50
	SL4L-LE	4-1/2" Sill, With Left End, 32" Long	17	\$14.50
	SL4L-NO	4-1/2" Sill, With No Ends, 32" Long	17	\$14.50
Keystone				
	KS3	Keystone for MG3 Moulding	5	\$13.75

**Prices are subject to change without notice

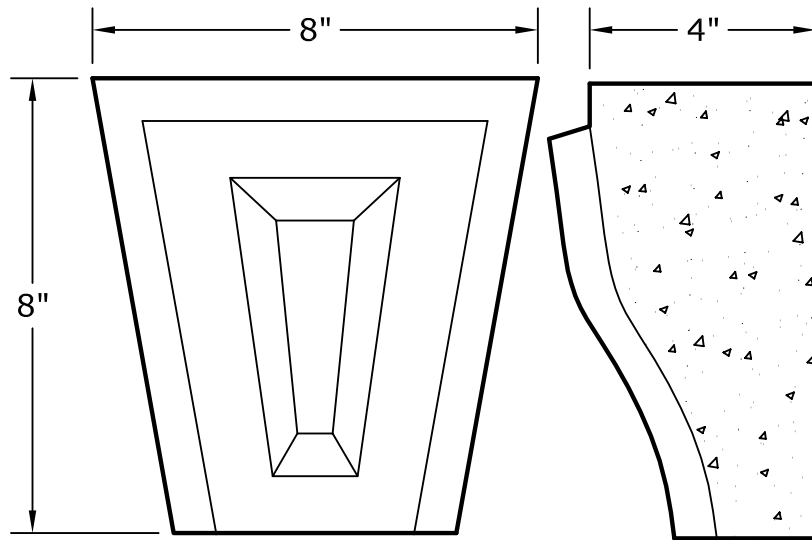

KS5-Keystone

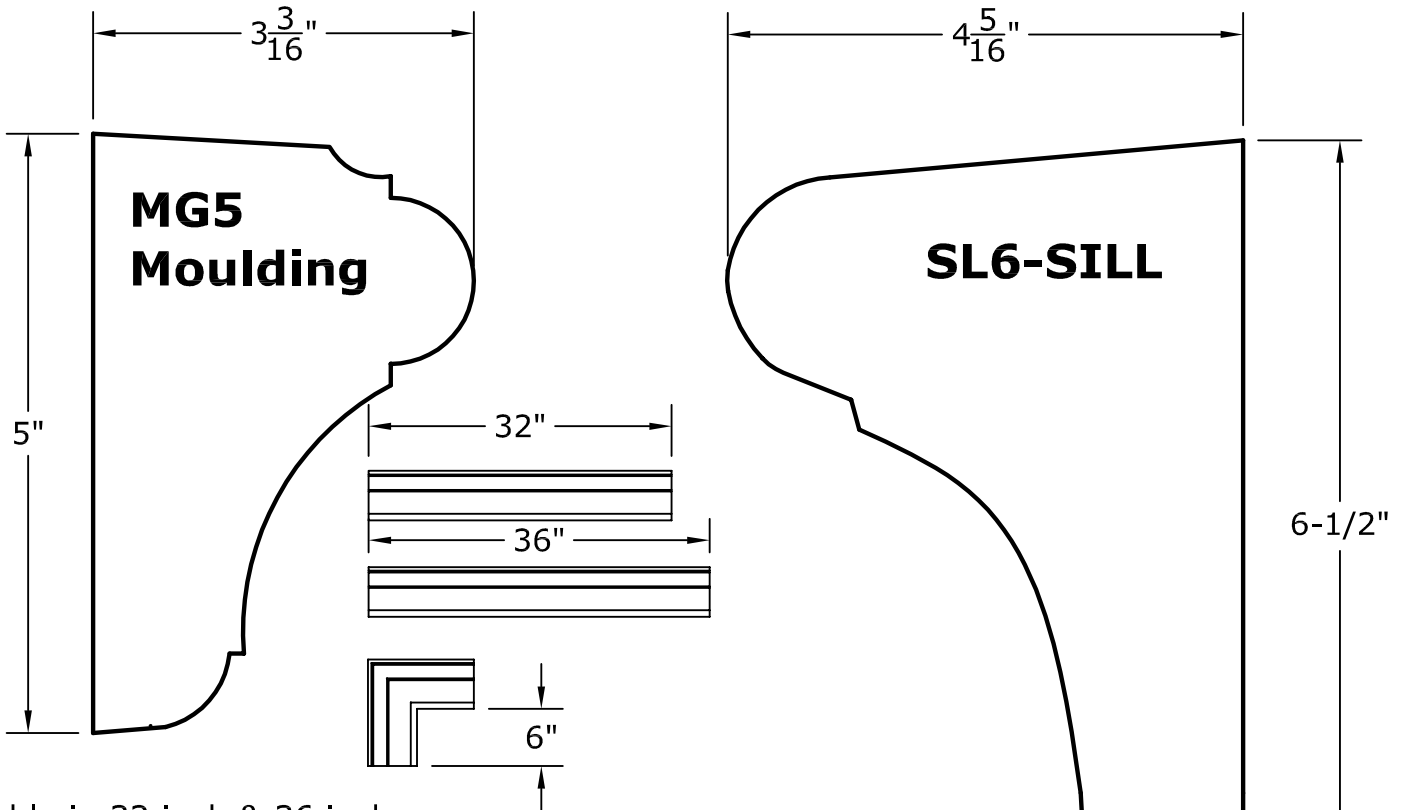
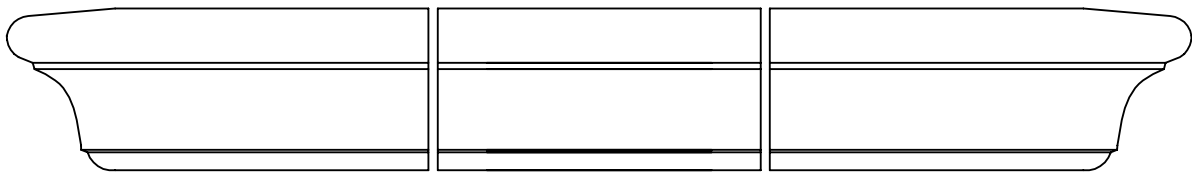

Available in 32 inch & 36 inch lengths
Corner Piece is 12" X 12"
(Outer Edge)

Available in 24 inch & 32 inch lengths. Left & Right Ends available

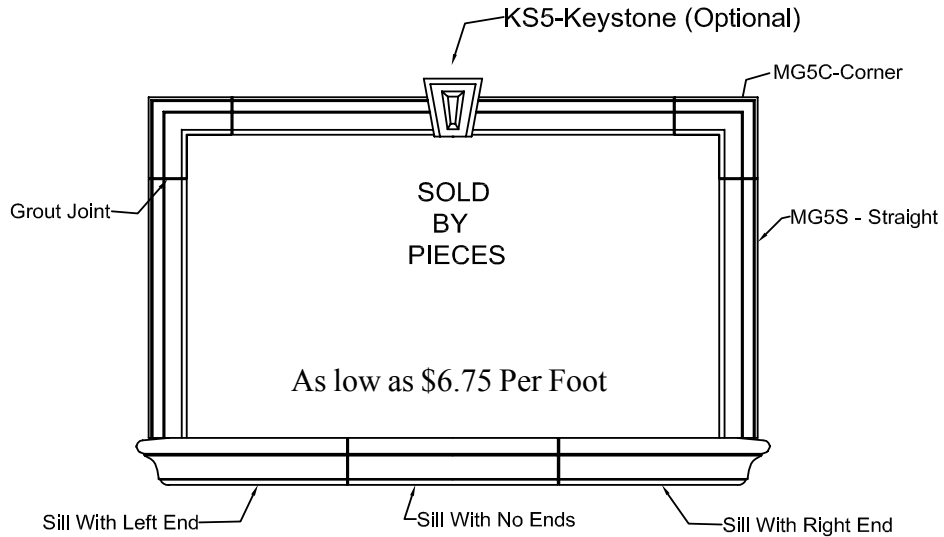

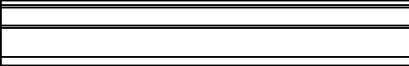
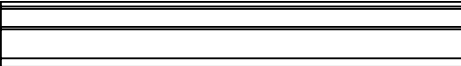
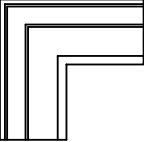
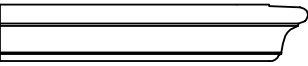
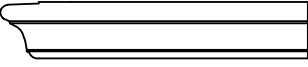
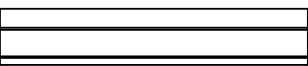
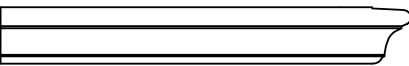
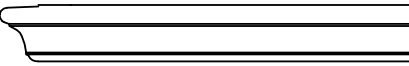
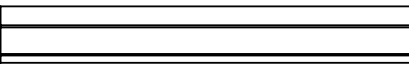
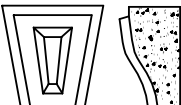
	Item	Description	Weight LBS	MSRP/ Price Per Piece
Mouldings				
	MG5S	5" Moulding, 32" Long	26.5	\$ 16.85
	MG5L	5" Moulding, 36" Long	30	\$ 20.25
	MG5C	Corner (6" X 6" inside)	13.5	\$ 13.50
Sills (Short)				
	SL6S-RE	6-1/2" Sill, With Right End, 24" Long	28	\$ 16.35
	SL6S-LE	6-1/2" Sill, With Left End, 24" Long	28	\$ 16.35
	SL6S-NE	6-1/2" Sill, With No Ends, 24" Long	28	\$ 16.35
Sills (Long)				
	SL6L-RE	6-1/2" Sill, With Right End, 32" Long	37	\$ 19.50
	SL6L-LE	6-1/2" Sill, With Left End, 32" Long	37	\$ 19.50
	SL6L-NO	6-1/2" Sill, With No Ends, 32" Long	37	\$ 19.50
Keystone				
	KS5	Keystone for MG5 Moulding	15	\$ 18.75

**Prices are subject to change without notice

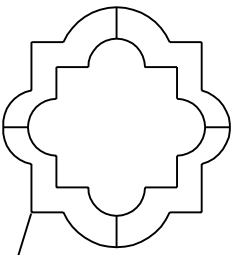
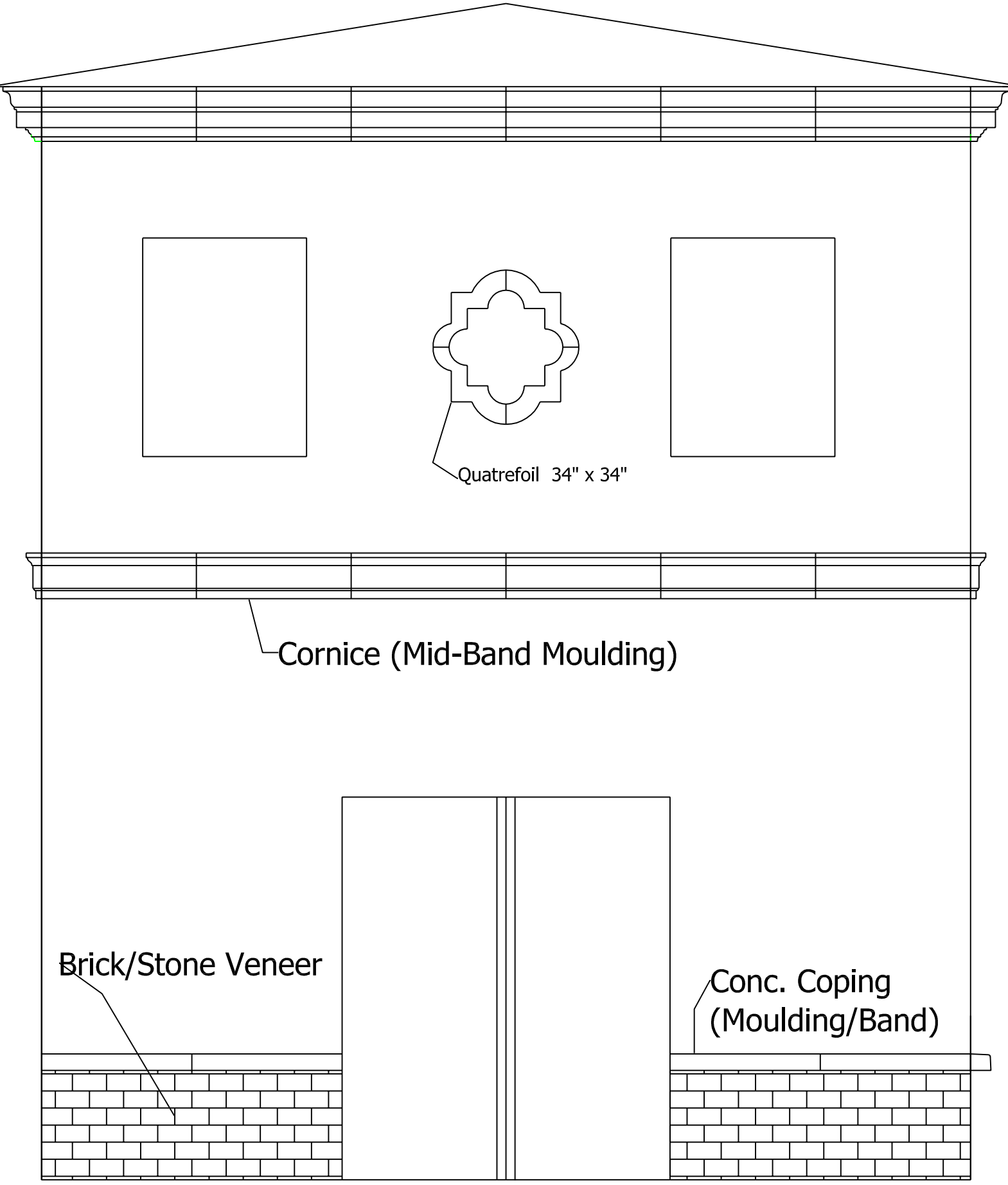

Quatrefoil 34" x 34"

Cornice (Mid-Band Moulding)

Brick/Stone Veneer

Conc. Coping (Moulding/Band)

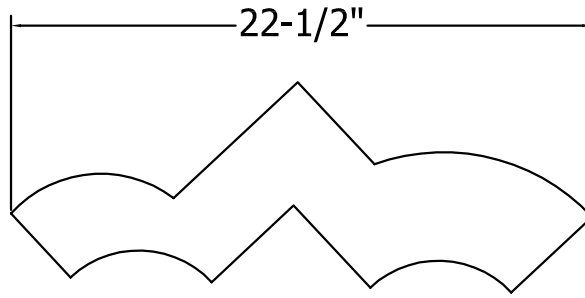
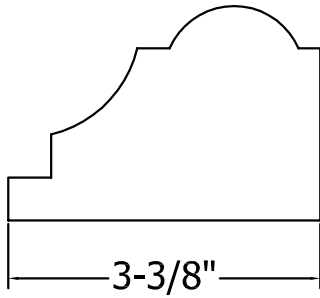

QF1-Quatrefoil 34" x 34" --(In Four Pieces)--1 SET MSRP: \$75.00

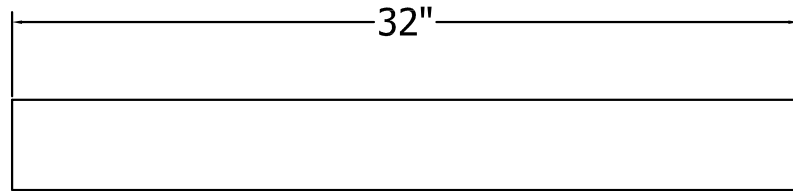
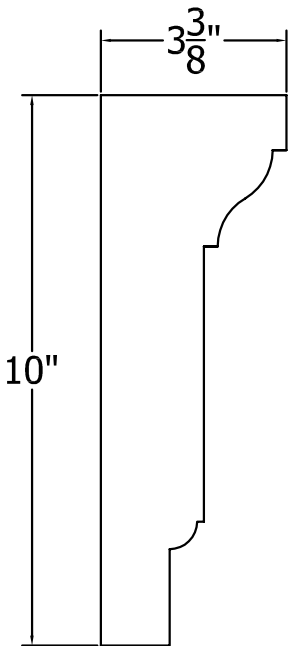

MG10-Cornice (Mid-Band Moulding/Trim)-10" x 32" Long
 Comes in 32" Long Pieces
 MSRP Per Piece: \$30.00

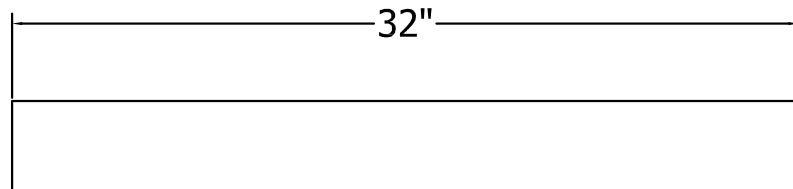
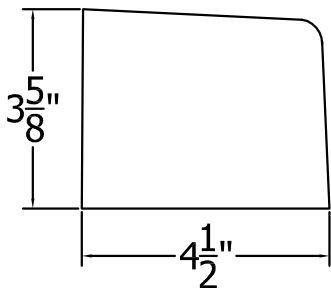

MG4-Moulding (Precast Conc. Coping for Veneer Stone/Brick)
 Comes in 32" Long Pieces
 MSRP Per Piece: \$15.00

SETTING THE PIECES

In most cases our products are set on brown coat of stucco using premium quality white thin-set cement mortar and are reinforced with mechanical attachment such as galvanized/ stainless steel screws. Each piece has an embedded metal bracket that have hole for the screws.

If your stucco is already finished with final (color) coat, The surface of the stucco must be scraped off where the molding is going to be installed. The mortar must bond to the surface well. In this case, the embedded brackets cannot be used. Therefore, instead of the brackets, screws must be put through the pieces. (First, drill a hole, then put the screws)

FIELD CUTTING

Almost in all cases field cutting is required during installation. Joint placements should be considered prior to cutting. Our products may be cut using masonry blades preferably diamond blade. (Dry/Wet Cut) In most cases, four or seven inch diamond blades will do the job.

CLEAN UP

Care should be taken during installation. Mortar spills should be cleaned immediately using water. You may also clean the precast using soap & water. Other masonry cleaners are available at specialty stores.

MATERIAL LIST

- Premium quality white thin-set mortar
- Screws (Galvanized/ Stainless Steel)
- Grout for joints

EQUIPMENT / TOOLS LIST

- Drill
- Cutting Saw (4" / 7" masonry blade)
- Level
- Mortar Mixer
- Measuring Tape
- Grout Bag
- Pencil

ABOVE INSTALLATION GUIDES ARE NOT WARRANTIES. IT IS THE CONTRACTORS OR INSTALLERS RESPONSIBILITY TO ASSURE ALL ITEMS ARE INSTALLED PROPERLY.

We make the moulding same radius as your door/window. We need the actual radius or diameter to be able to make the radius. The Worksheet below will help determining the radius.

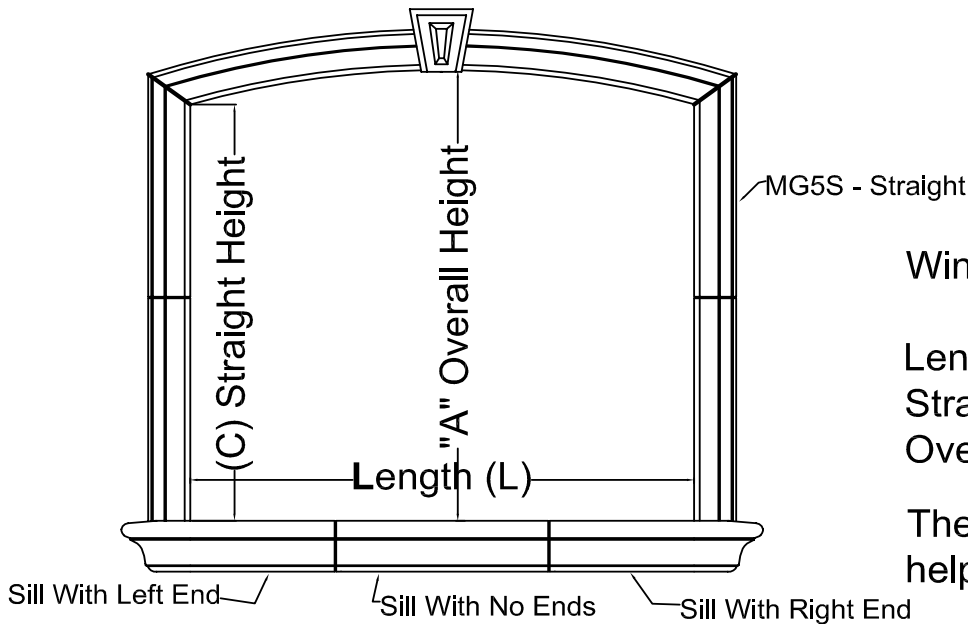

Window Type: Eyebrow

Length (L): _____
 Straight Height (C): _____
 Overall Height (A): _____

The measurements above will help us determine the radius.

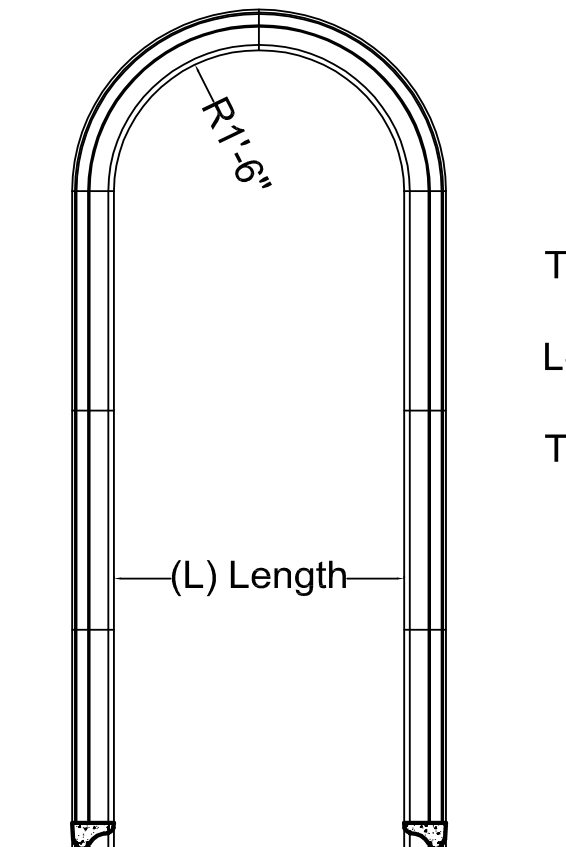

Type: Door Full Arch (half circle)

Length (L): _____

The radius is half of the length.

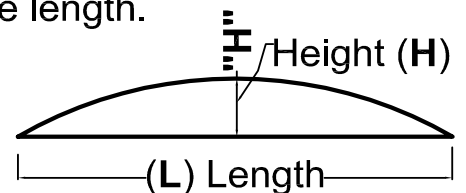

Height (H): _____
 Length (L): _____

An arc of a circle. The above measurement will help us determine the radius.

AVAILABLE IN FOUR NATURAL EARTH TONE COLORS



BUFF

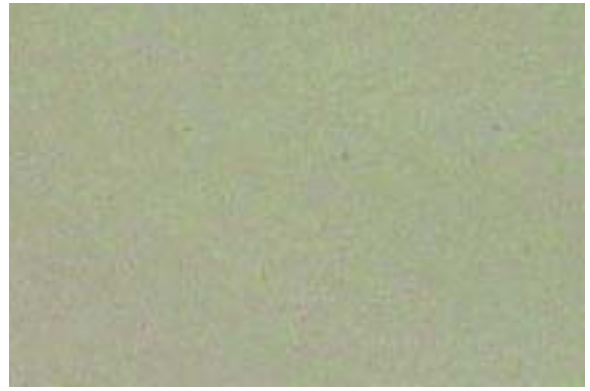

SEQUOIA BROWN



STONE WHITE



TAN

The above colors are graphic representation, the printing process may not accurately reflect product color. We strongly recommend that you see an actual sample prior to ordering.

For any questions, please feel free to contact our main office:

(877) 763-7866 Toll Free or sales@trimstone.com Web Site: www.trimstone.com

Distributed By:



Manufactured By:



SANDSTONE DESIGNS, INC

38955 10th St. East, Palmdale, CA 93550

www.sandstonedesigns.com

(877) 763-7866 Toll Free (661) 947-1003 Fax

© 2006 Sandstone Designs, Inc. All Rights Reserved